











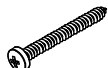







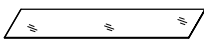

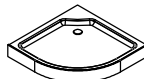
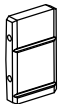

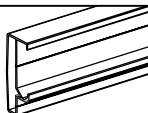

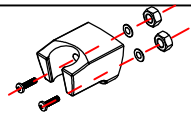
A		8	H		4	O		2
B	 ST4X40	8	I		2	P		2
C		2	J	 ST4X12	8	Q		8
D		2	K		4	R	 ST4X8	4
E		2	L	 ST4X10	4	S		1
F		4	M		2			
G		2	N		2			

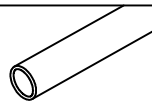
A1		1	E1	 ST4X12	22	I1		1
B1		1	F1		1	J1		1
C1		1	G1		1	K1		1
D1		2	H1		1			



Ø6,Ø2.8

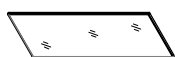
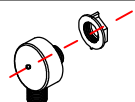
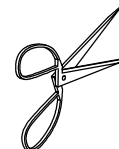
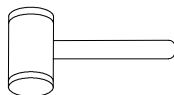
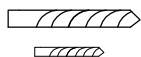
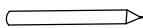
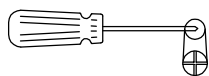
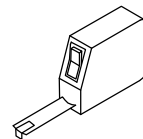
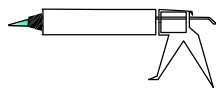
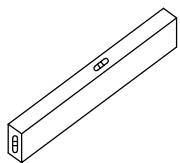
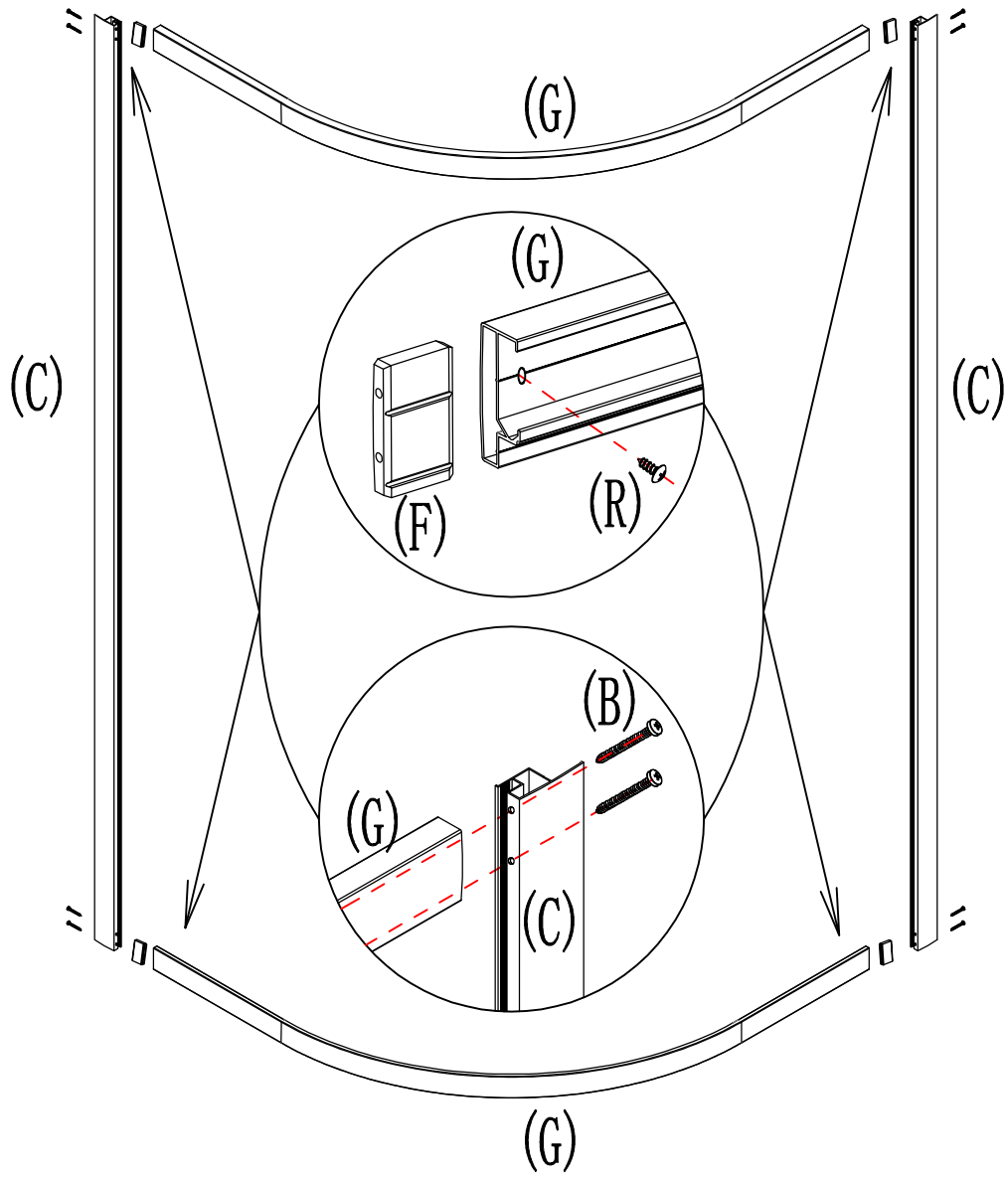
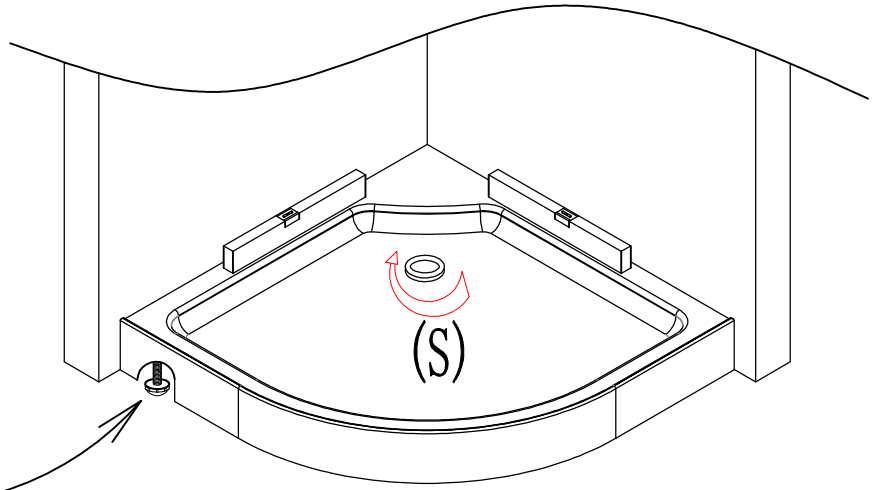
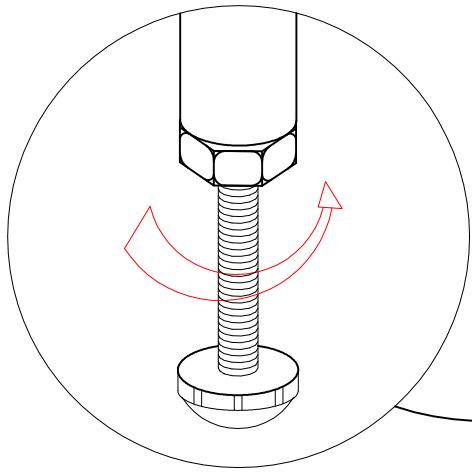

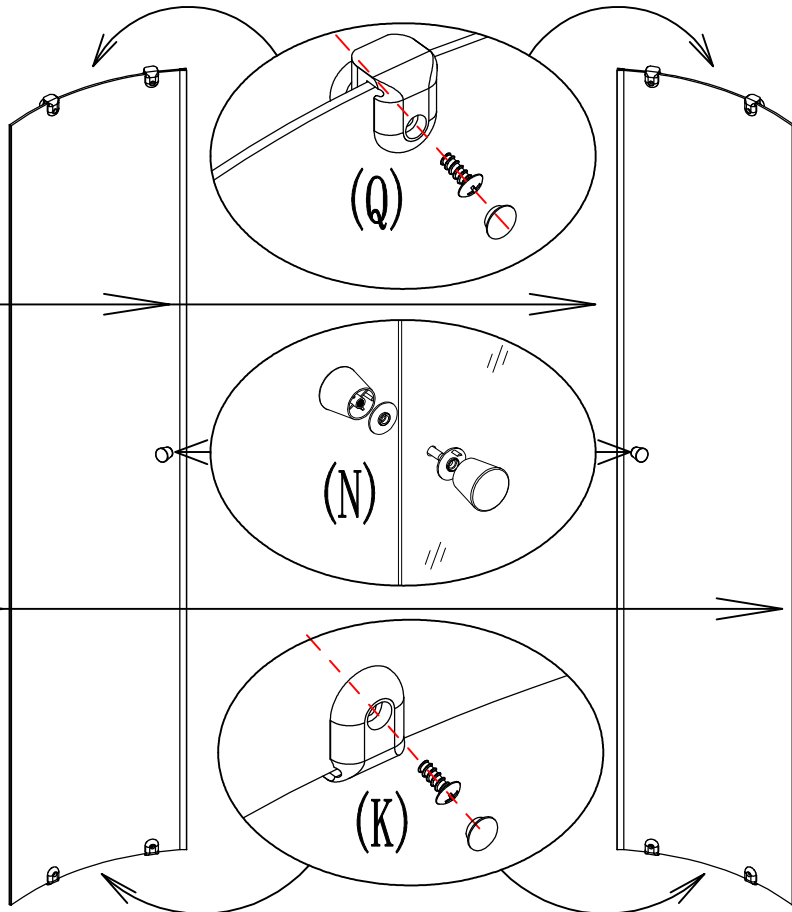
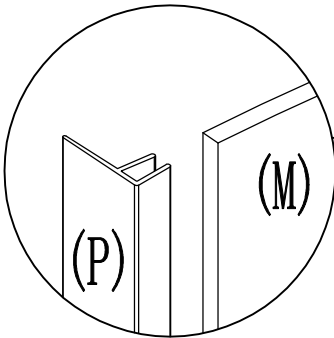
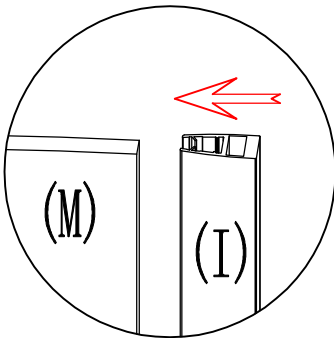
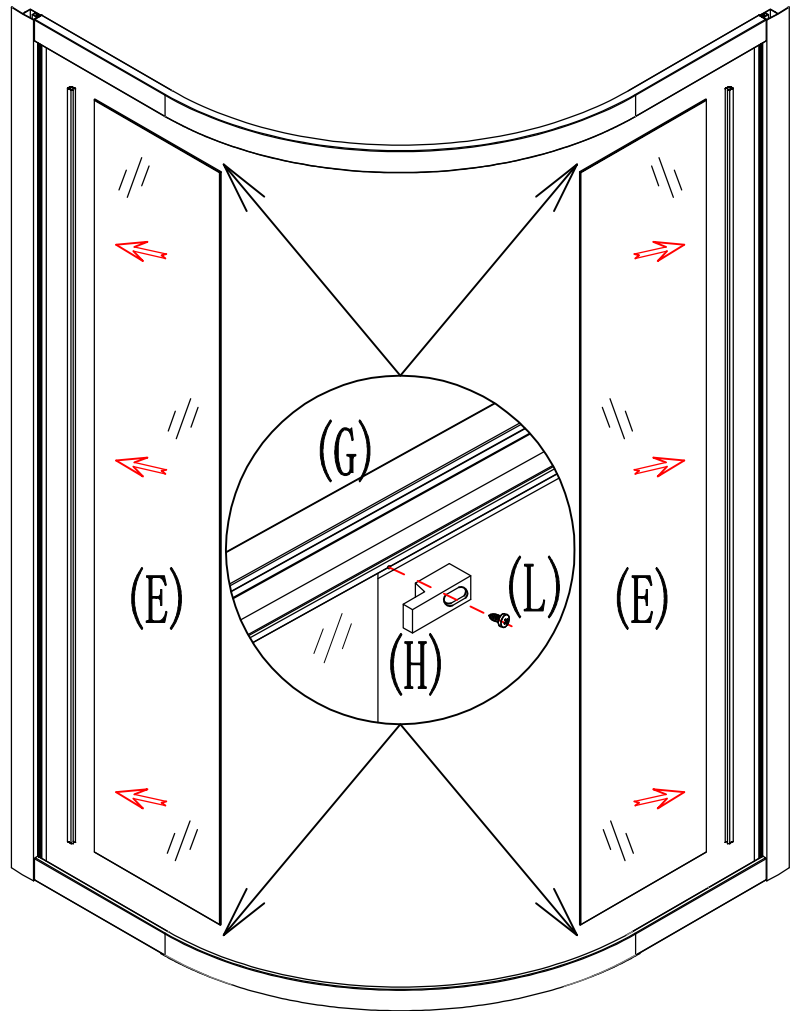
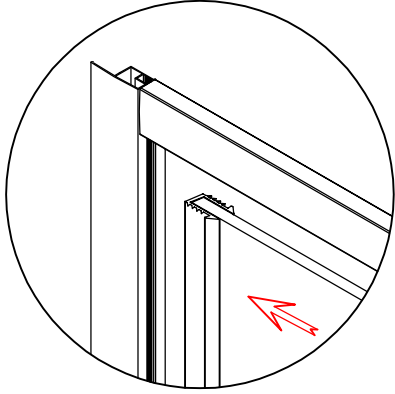
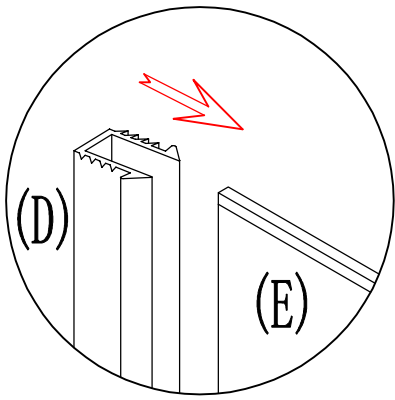

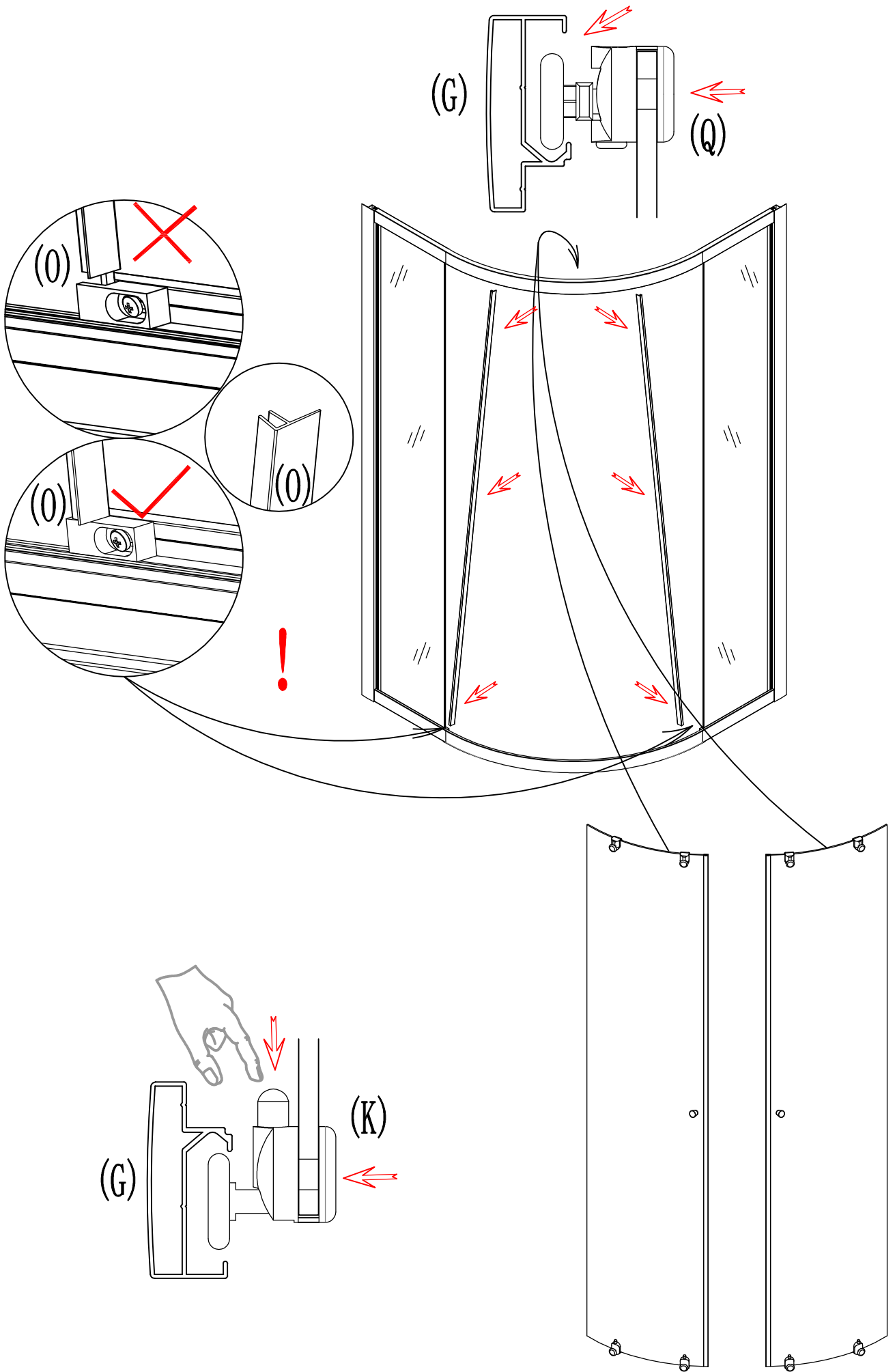

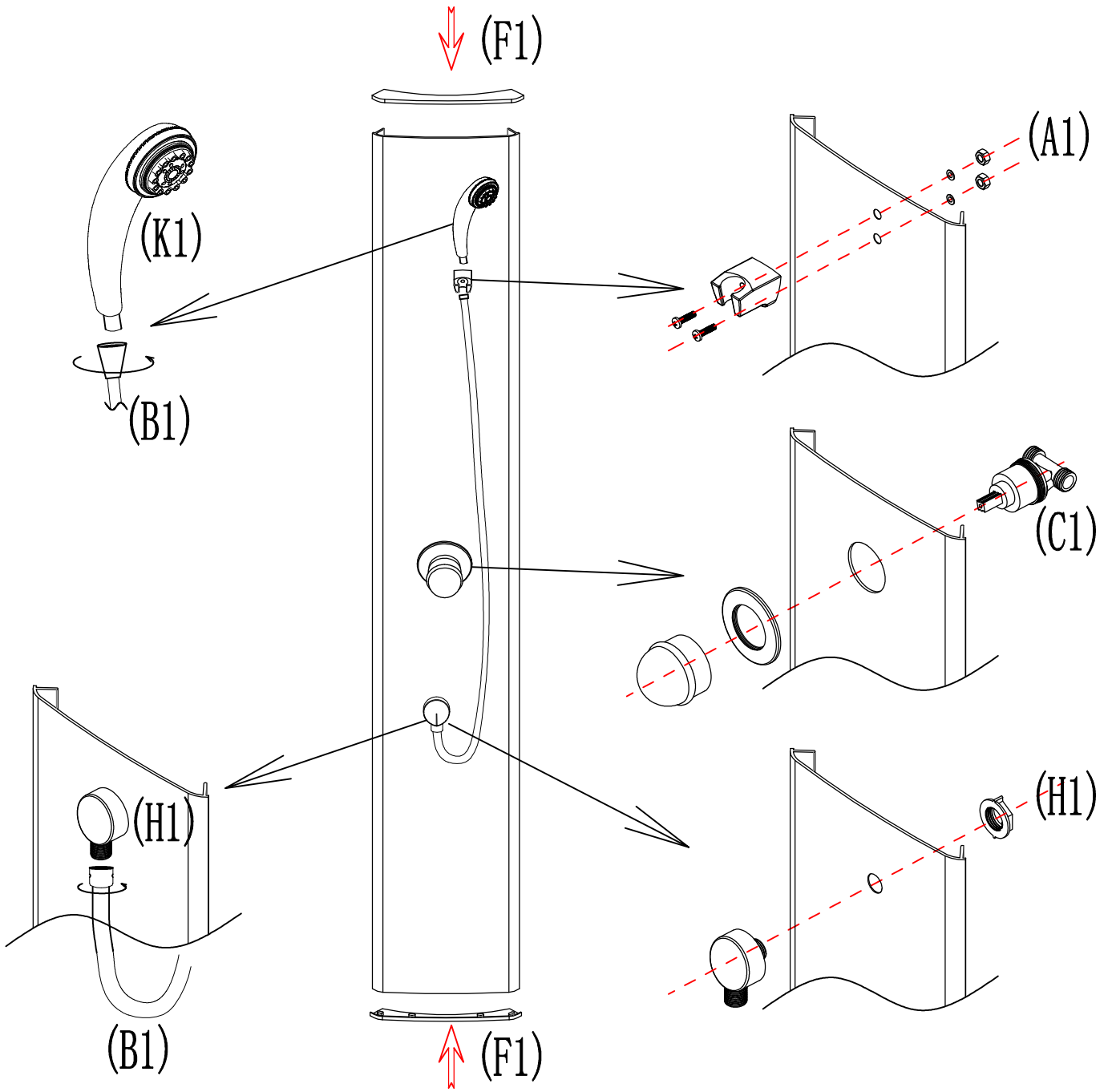

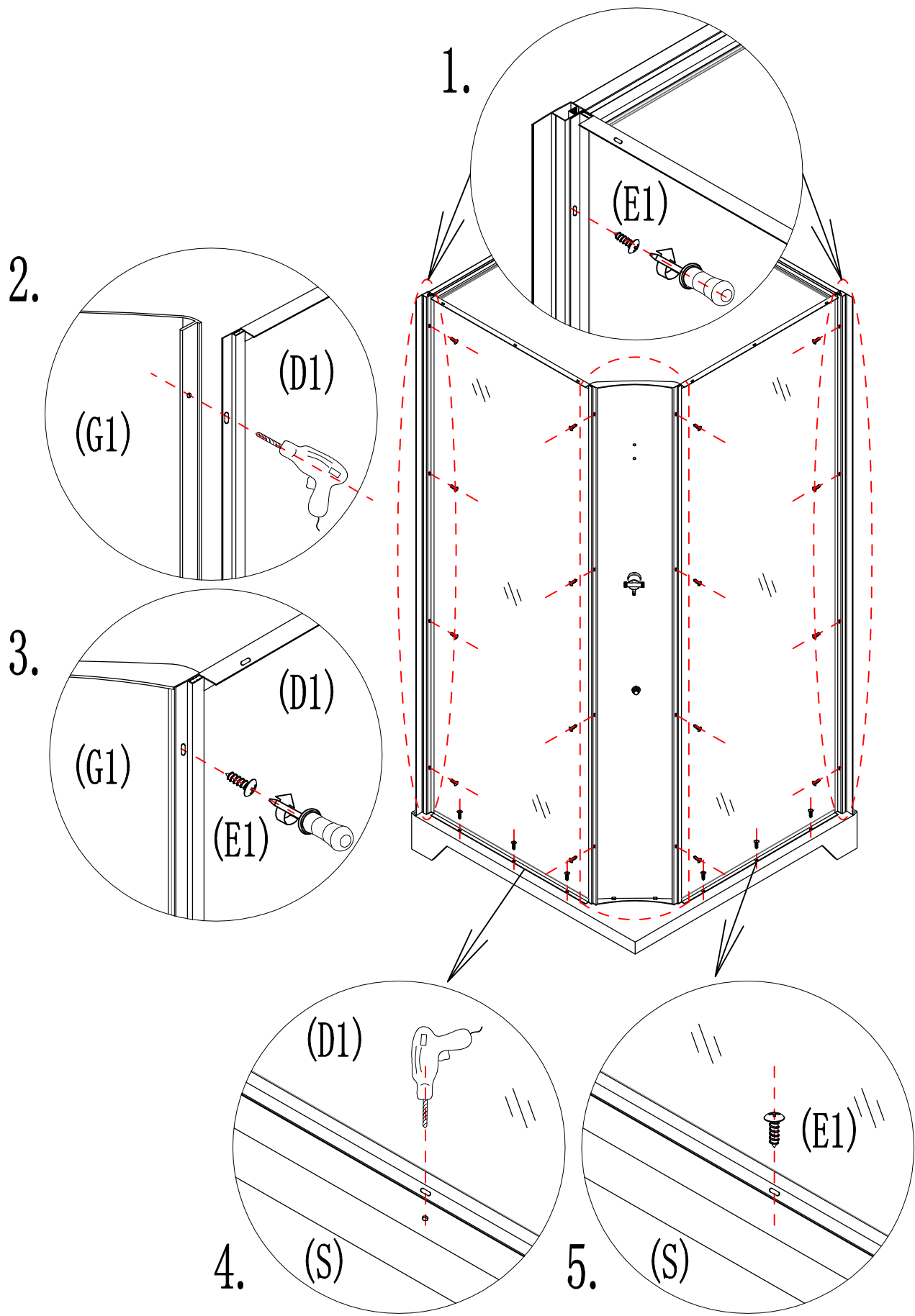

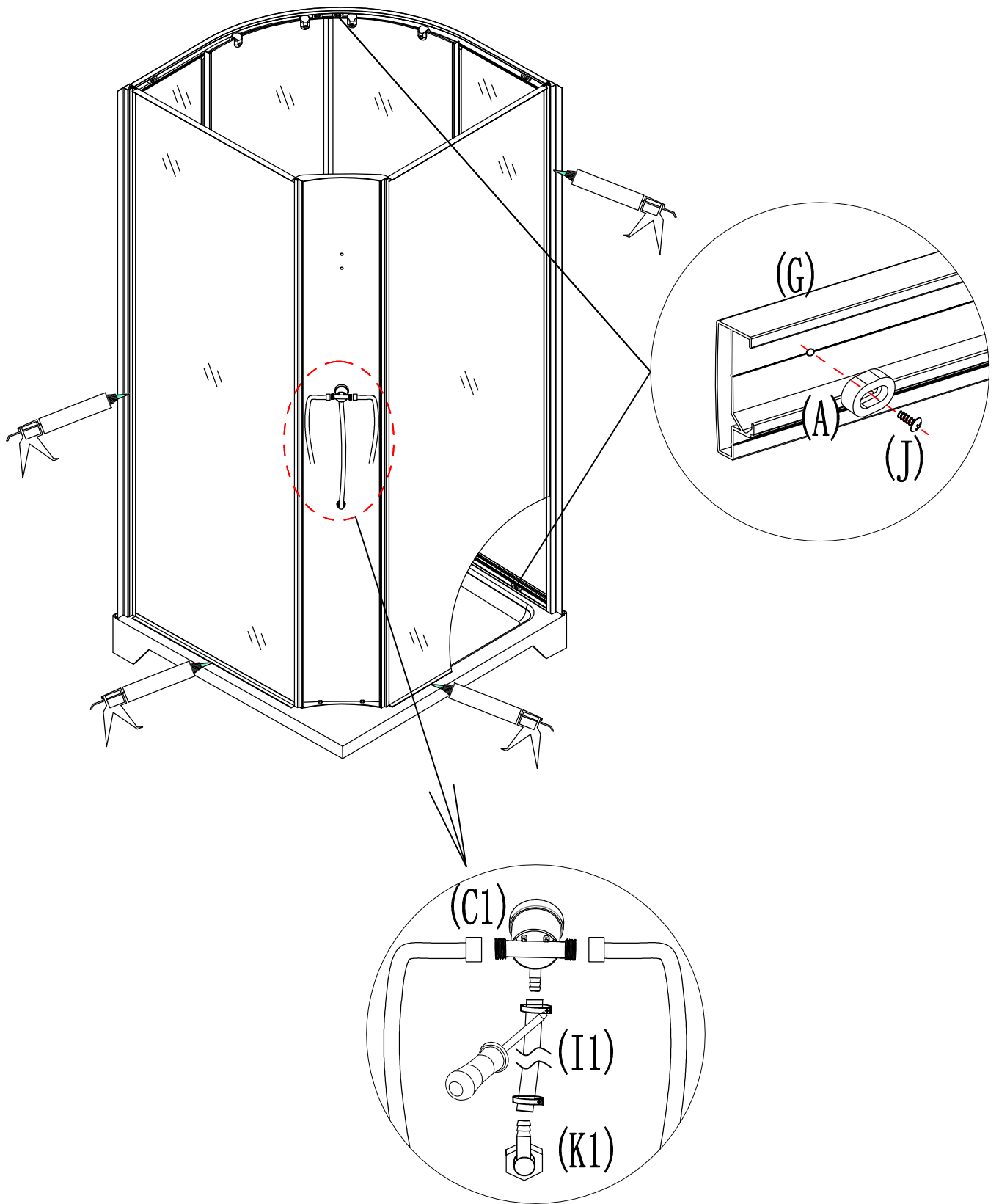

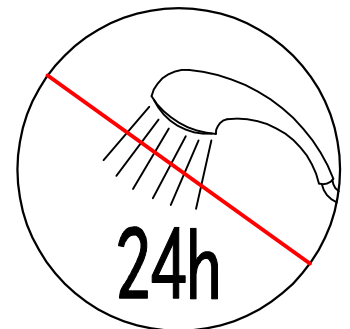
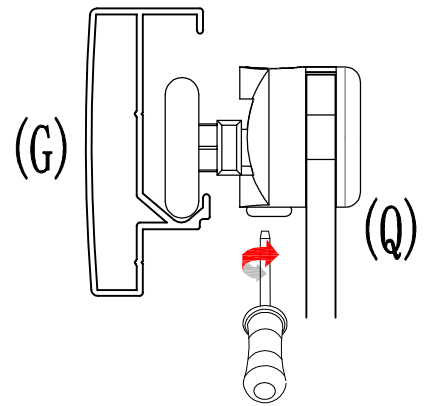
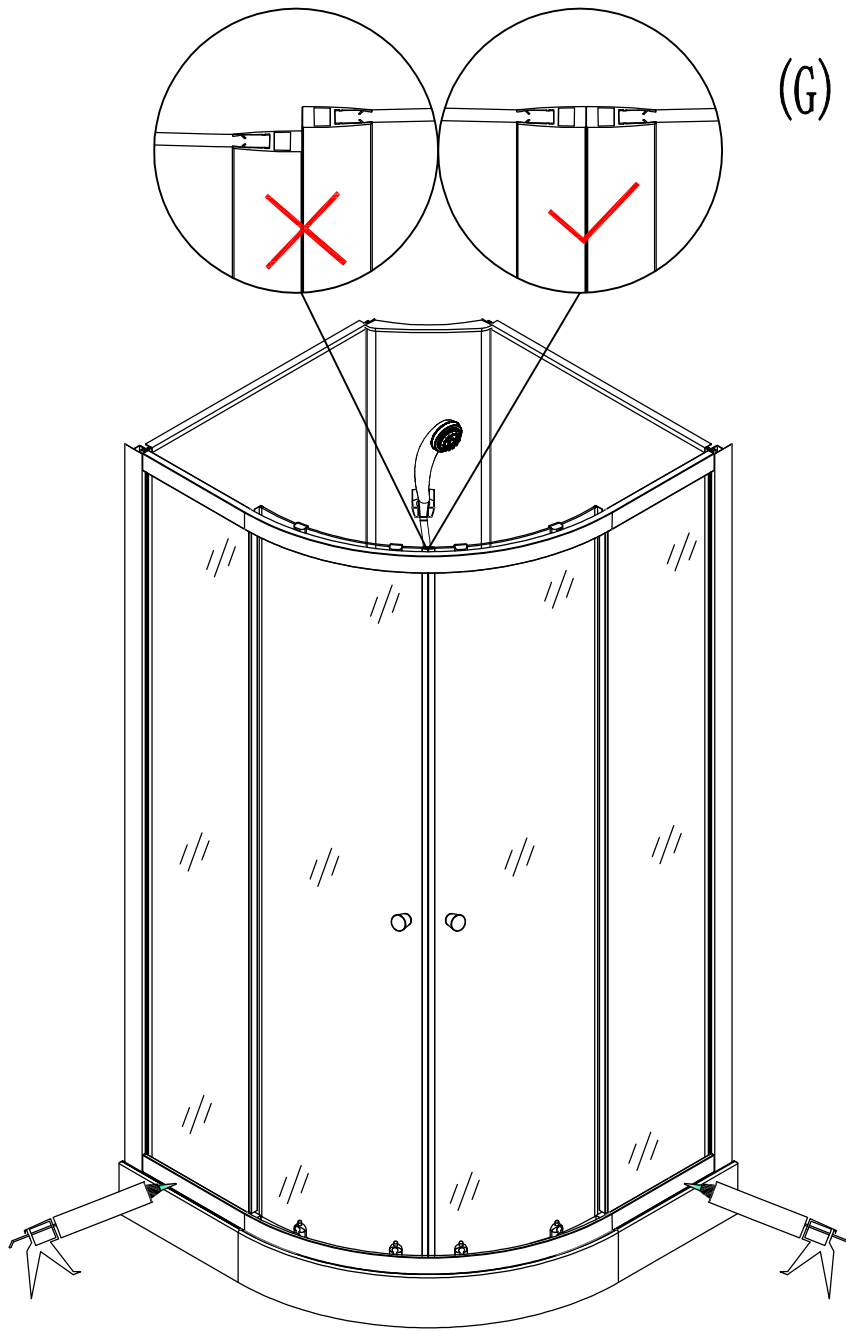

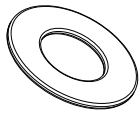

M12=6

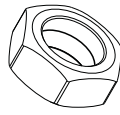

M12=23

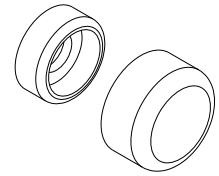

=3

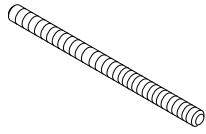

M12 X 10CM=1

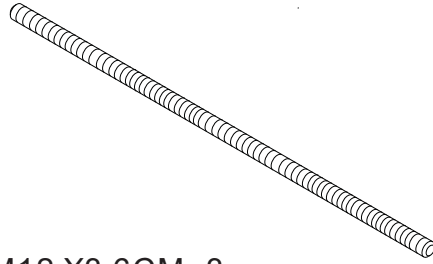

M12 X3 6CM=3

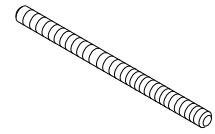

M12 X 18CM=1

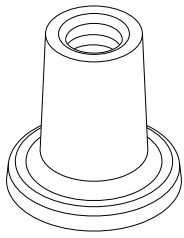

=5

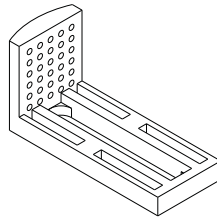

=3

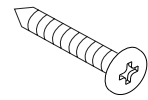

M4 X 20=3

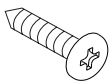

M4 X 12=4

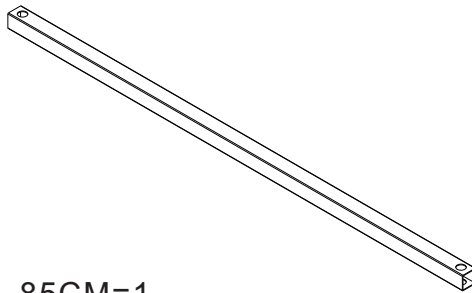

85CM=1

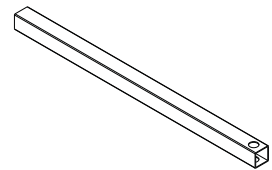

45CM=2

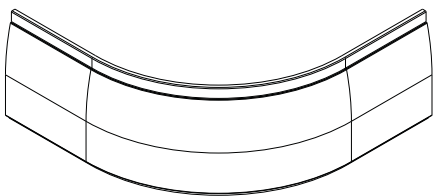

=1

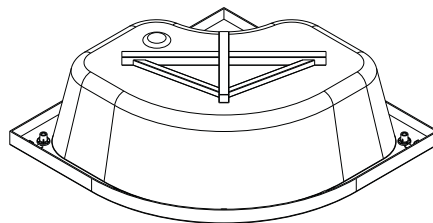

=1

